

Varenummer: 3901150007700
 Beskrivelse: Snekkegear med fri indgangsaksel
 VF 150P-7-HS

Mål

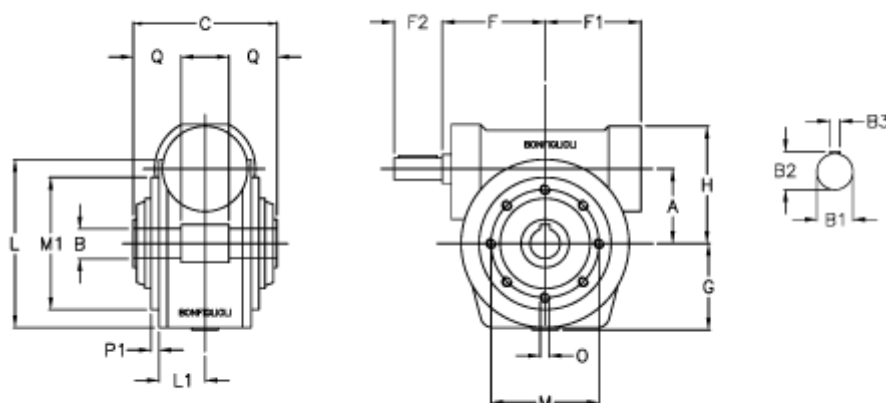

a	= 150.0	F1	= 179	O	= M14x23
B	= 50	F2	= 65	P1	= 4.0
B1	= 35	g	= 180	Q	= 55.0
B2	= 38.0	H	= 218		
B3	= 10	L	= 250.0		
Betegnelse	= VF 150P-xx-HS	L1	= 83.5		
C	= 175	m	= 215		
F	= 185.0	M1	= 180		